



# Desk & Seat Occupancy Sensor

Featuring LoRaWAN®

**VS34x**

User Guide



## Safety Precautions

Milesight will not shoulder responsibility for any loss or damage resulting from not following the instructions of this operating guide.

- ❖ The device must not be disassembled or remodeled in any way.
- ❖ Do not expose the PIR lens to direct sunlight.
- ❖ Do not paint or clean the PIR lens, or it will affect the detection of the device.
- ❖ Do not place the device where the temperature is below/above the operating range.
- ❖ Do not place the device close to objects with naked flames, heat source (oven or sunlight), cold source, liquid, and extreme temperature changes.
- ❖ When installing the battery, please install it accurately, and do not install the reverse or wrong model.
- ❖ The device must never be subjected to shocks or impacts.

## Declaration of Conformity

VS34x is in conformity with the essential requirements and other relevant provisions of the CE, FCC, and RoHS.



### Copyright © 2011-2023 Milesight. All rights reserved.

All information in this guide is protected by copyright law. Whereby, no organization or individual shall copy or reproduce the whole or part of this user guide by any means without written authorization from Xiamen Milesight IoT Co., Ltd.

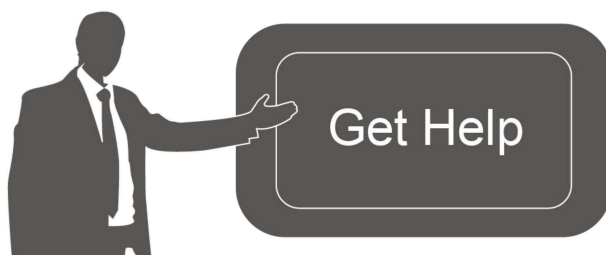

For assistance, please contact

Milesight technical support:

Email: [iot.support@milesight.com](mailto:iot.support@milesight.com)

Support Portal: [support.milesight-iot.com](http://support.milesight-iot.com)

Tel: 86-592-5085280

Fax: 86-592-5023065

Address: Building C09, Software Park  
Phase III, Xiamen 361024,  
China

**Revision History**

Date	Doc Version	Description
July 20, 2023	V 1.0	Initial version

# Contents

1. Product Introduction .....	5
1.1 Overview .....	5
1.2 Key Features .....	5
2. Hardware Introduction .....	5
2.1 Packing List .....	5
2.2 Hardware Overview .....	6
2.3 Power Button and LED Indicator .....	6
2.4 Dimensions (mm) .....	7
3. Operation Guide .....	7
3.1 NFC Configuration .....	7
3.2 LoRaWAN® Settings .....	8
3.3 General Settings .....	10
3.4 Milesight D2D Settings .....	11
3.5 Maintenance .....	12
3.5.1 Upgrade .....	12
3.5.2 Backup .....	12
3.5.3 Reset to Factory Default .....	13
4. Installation .....	14
5. Device Payload .....	16
5.1 Basic Information .....	17
5.2 Sensor Data .....	17
5.3 Downlink Commands .....	17

# 1. Product Introduction

## 1.1 Overview

The VS34x is an occupancy sensor designed to detect whether desks or seats in a workspace are occupied, allowing for better management and optimization of space usage. The standard version of the sensor VS340 uses PIR technology for detection. The pro version VS341 applies additional thermopile IR technology to provide more accurate and precise detection capabilities. VS34x features an adjustable field of view angle for greater flexibility in different scenarios.

With wireless detection and easy configuration, the VS34x offers reliable and convenient desk or seat arrangement optimization. It is compatible with Milesight LoRaWAN® gateway and IoT Cloud solution, enabling real-time monitoring of desks and seats' status for effective remote management.

## 1.2 Key Features

- High accuracy rate up to 98% for pro version and 95% for standard version
- Dual versions are available, standard and pro, to accommodate different latency requirements
- Provide different types of PIR covers for adjustable and flexible field angle and different detecting ranges.
- Support Milesight D2D protocol to enable ultra-low latency and direct control without gateway
- Equipped with NFC for one touch configuration, support card emulation mode
- Function well with standard LoRaWAN® gateways and network servers
- Compatible with Milesight IoT Cloud

# 2. Hardware Introduction

## 2.1 Packing List



1 × VS34x Sensor



4 × PIR Covers



1 × 3M Tape



2 × Mounting Kits



1 × Quick Start Guide

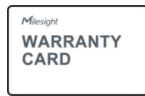

1 × Warranty Card

**!** If any of the above items is missing or damaged, please contact your sales representative.

## 2.2 Hardware Overview

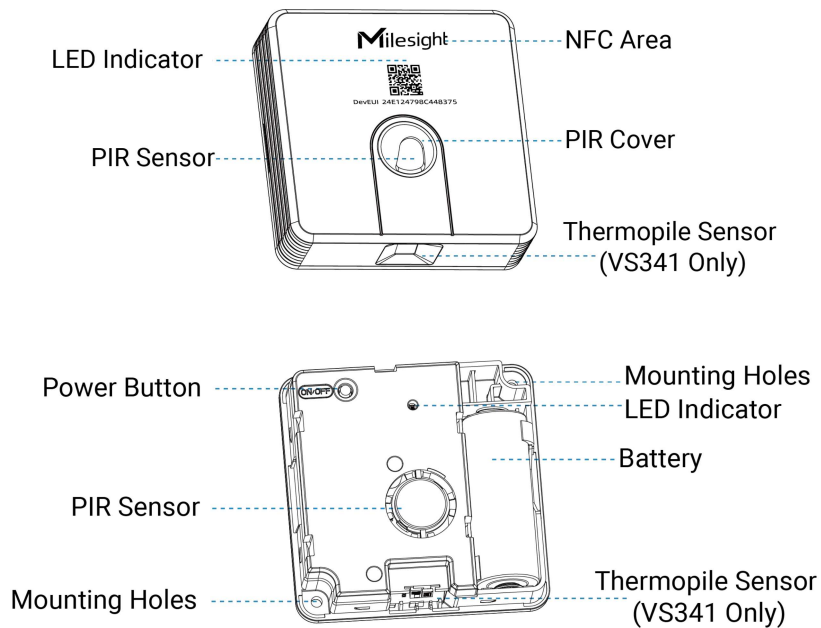

## 2.3 Power Button and LED Indicator

Function	Action	LED Indicator
Power On	Press and hold the power button for more than 3 seconds.	Off → On
Power Off		On → Off
Check On/Off Status	Quick press the power button once.	Light On: Device is on.
		Light Off: Device is off.
Reset to Factory Default	Press and hold the power button for more than 10 seconds.	Blink quickly
Occupancy Status	Vacant → Occupied	Blinks twice
	Occupied → Vacant	Blinks twice

## 2.4 Dimensions (mm)

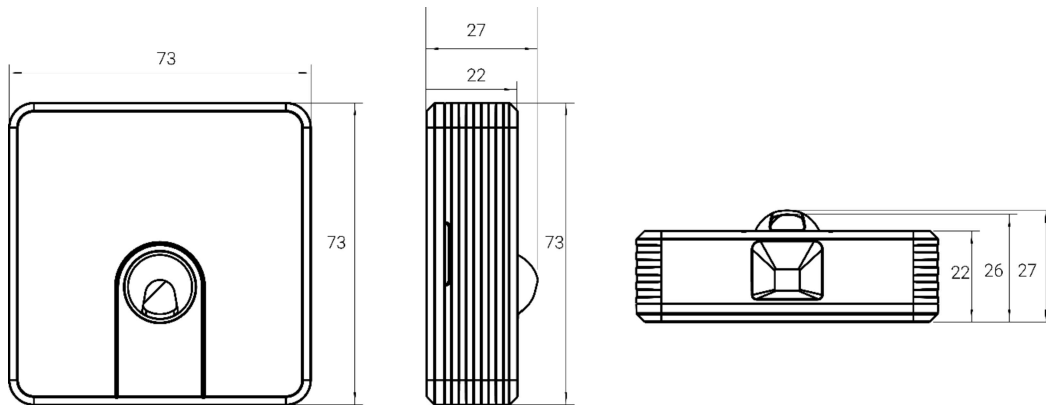

## 3. Operation Guide

### 3.1 NFC Configuration

VS34x sensor can be monitored and configured via NFC. Please refer to the following configuration steps.

1. Download and install the “Milesight ToolBox” App from Google Play or Apple App Store.
2. Enable NFC on the a smartphone and launch Milesight ToolBox.
3. Attach the NFC area of smartphone to the device, and click “NFC Read” to read device information. The basic information and settings of the device will be shown on ToolBox App if it’s recognized successfully. You can read and configure the device by tapping the Read/Write device on the App. In order to protect the security of the device, please change the password when first configuring. The default password is **123456**.

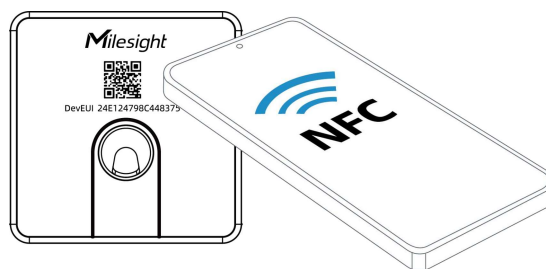

**Note:**

- 1) Ensure the location of NFC area of the smartphone and it’s recommended to take off phone case.
- 2) If the smartphone fails to read/write configurations via NFC, remove the phone and try again.
- 3) VS34x sensor can also be configured by dedicated NFC reader provided by Milesight IoT.

## 3.2 LoRaWAN® Settings

Go to **Device > Settings > LoRaWAN® Settings** of ToolBox App to configure AppEUI, Join Type, Application Key and other information. You can also keep all settings by default.

Device EUI

24E124787D180089

\* APP EUI

24e124c0002a0001

\* Application Port  85

Join Type

OTAA

\* Application Key

\*\*\*\*\*

LoRaWAN Version

V1.0.3

Parameters	Description
Device EUI	Unique ID of the device which can also be found on the label.
App EUI	Default App EUI is 24E124C0002A0001.
Application Port	The port is used for sending and receiving data, default port is 85.
Join Type	OTAA and ABP mode are available.
Application Key	Appkey for OTAA mode, the default is 5572404C696E6B4C6F52613230313823.
Network Session Key	Nwkskey for ABP mode, the default is 5572404C696E6B4C6F52613230313823.
Application Session Key	Appskey for ABP mode, the default is 5572404C696E6B4C6F52613230313823.
Device Address	DevAddr for ABP mode, the default is the 5th to 12th digits of the SN.
LoRaWAN® Version	V1.0.2 and V1.0.3 are available.
Work Mode	It's fixed as Class A.
RX2 Data Rate	RX2 data rate to receive downlinks.
RX2 Frequency	RX2 frequency to receive downlinks. Unit: Hz



Channel Mode	Select Standard-Channel mode or Single-Channel mode. When Single-Channel mode is enabled, only one channel can be selected to send uplinks. Please enable Single-Channel mode if connected to DS7610.														
Channel	<p>Enable or disable the frequency to send uplinks.</p> <p>Examples:</p> <p>1, 40: Enabling Channel 1 and Channel 40</p> <p>1-40: Enabling Channel 1 to Channel 40</p> <p>1-40, 60: Enabling Channel 1 to Channel 40 and Channel 60</p> <p>All: Enabling all channels</p> <p>Null: Indicate that all channels are disabled</p> <div data-bbox="459 703 963 763"> <input type="text" value="Standard-Channel"/> </div> <p data-bbox="459 786 735 815">Enable Channel Index <span>(i)</span></p> <div data-bbox="459 831 963 891"> <input type="text" value="0-95"/> </div> <table border="1" data-bbox="459 936 963 1451"> <thead> <tr> <th data-bbox="485 943 544 972">Index</th> <th data-bbox="730 943 906 972">Frequency/MHz <span>(i)</span></th> </tr> </thead> <tbody> <tr> <td data-bbox="485 1039 544 1068">0 - 15</td> <td data-bbox="730 1039 871 1068">470.3 - 473.3</td> </tr> <tr> <td data-bbox="485 1113 544 1142">16 - 31</td> <td data-bbox="730 1113 871 1142">473.5 - 476.5</td> </tr> <tr> <td data-bbox="485 1187 544 1216">32 - 47</td> <td data-bbox="730 1187 871 1216">476.7 - 479.7</td> </tr> <tr> <td data-bbox="485 1261 544 1290">48 - 63</td> <td data-bbox="730 1261 871 1290">479.9 - 482.9</td> </tr> <tr> <td data-bbox="485 1335 544 1364">64 - 79</td> <td data-bbox="730 1335 871 1364">483.1 - 486.1</td> </tr> <tr> <td data-bbox="485 1408 544 1438">80 - 95</td> <td data-bbox="730 1408 871 1438">486.3 - 489.3</td> </tr> </tbody> </table>	Index	Frequency/MHz <span>(i)</span>	0 - 15	470.3 - 473.3	16 - 31	473.5 - 476.5	32 - 47	476.7 - 479.7	48 - 63	479.9 - 482.9	64 - 79	483.1 - 486.1	80 - 95	486.3 - 489.3
Index	Frequency/MHz <span>(i)</span>														
0 - 15	470.3 - 473.3														
16 - 31	473.5 - 476.5														
32 - 47	476.7 - 479.7														
48 - 63	479.9 - 482.9														
64 - 79	483.1 - 486.1														
80 - 95	486.3 - 489.3														
Confirmed Mode	If the device does not receive ACK packet from network server, it will resend data once.														
Rejoin Mode	<p>Reporting interval <math>\leq</math> 35 mins: the device will send a specific number of LinkCheckReq MAC packets to the network server every reporting interval or every double reporting interval to validate connectivity; If there is no response, the device will re-join the network.</p> <p>Reporting interval <math>&gt;</math> 35 mins: the device will send a specific number of LinkCheckReq MAC packets to the network server every reporting interval to validate connectivity; If there is no response, the device will re-join the network.</p>														

Set the number of packets sent	When rejoin mode is enabled, set the number of LinkCheckReq packets sending.. <b>Note:</b> the actual sending number is <b>Set the number of packet sent + 1</b> .
ADR Mode	Allow network server to adjust data rate of the device.
Spread Factor	If ADR is disabled, the device will send data via this spread factor.
Tx Power	Transmit power of the device.

**Note:**

- 1) Please contact sales for device EUI list if there are many units.
- 2) Please contact sales if you need random App keys before purchase.
- 3) Select OTAA mode if you use Milesight IoT cloud to manage devices.
- 4) Only OTAA mode supports rejoin mode.

### 3.3 General Settings

Go to **Device > Setting > General Settings** of ToolBox App to set the reporting interval, etc.

Reporting Interval  min

Time to Report Vacancy / s

LED Indicator

Change Password

Parameters	Description
Reporting Interval	The interval of reporting PIR status and battery level to network server. Default: 1440 mins, Range: 1 - 1440 mins <b>Note:</b> VS34x will also report "Occupied" status immediately when it detects motions.
Time to Report Vacancy /s	A "Vacant" status will be reported if the device does not detect motion within a certain period of time. VS340: Default: 5 min, Range: 1 – 30 min VS341: Default: 60 s, Range: 15 - 600 s
LED Indicator	Enable or disable the LED to indicate occupancy status.
Change Password	Change the password for ToolBox App to write this device.

### 3.4 Milesight D2D Settings

Milesight D2D protocol is developed by Milesight and used for setting up transmission among Milesight devices without gateway. When the Milesight D2D setting is enabled, VS34x can work as a Milesight D2D controller to send control commands to trigger Milesight D2D agent devices.

1. Configure RX2 data rate and RX2 frequency in LoRaWAN<sup>®</sup> settings, it is suggested to change the default value if there are many LoRaWAN<sup>®</sup> devices around.
2. Go to **Device > Settings > D2D Settings** to enable D2D function and configure the D2D settings.

Enable

D2D Key

Occupied

Control command

LoRa Uplink [i](#)

Control Time /min [i](#)

Vacant

Parameters	Description
Enable	Enable or disable Milesight D2D feature.
D2D Key	Define a unique D2D key which is the same as the setting in D2D agent device. Default value: 5572404C696E6B4C6F52613230313823
Occupied/Vacant	Enable one of the status modes. When VS34x detects this status, it will send the control command to corresponding Milesight D2D agent devices.
Control command	Define a 2-byte hexadecimal control command (0x0000 to 0xffff).
LoRa Uplink	If enabled, a LoRaWAN <sup>®</sup> uplink packet that contains the occupancy status will be sent to gateway after the Milesight D2D control command is sent.
Control Time /min <sup>1</sup>	After receiving commands from VS34x, Milesight D2D agent devices will take corresponding actions for this duration. Default: 5 mins, Range: 1 - 1440 mins

<sup>1</sup> This feature is under development on Milesight D2D agent devices.

## 3.5 Maintenance

### 3.5.1 Upgrade

1. Download firmware from Milesight website to your smartphone.
2. Go to **Device > Maintenance** of ToolBox App, tap **Browse** to import firmware and upgrade the device.

**Note:**

- 1) Operation on ToolBox is not supported during upgrade.
- 2) Only Android version ToolBox supports the upgrade feature.

Status	Setting	Maintenance
SN	6787D18008970013	
Model	VS341-470M	
Firmware Version	V1.1-a2	
Hardware Version	V1.0	
Manual Upgrade		
<a href="#">Browse</a>		

### 3.5.2 Backup

VS34x supports backup templates for easy and quick device configuration in bulk. Backup is only for devices with the same model and LoRaWAN<sup>®</sup> frequency band.

1. Go to **Template** page on the App and save current settings as a template. The saved templates are also editable.
2. Select one saved template and click **Write**, then attach the smartphone to another device via NFC to reuse the configuration template.

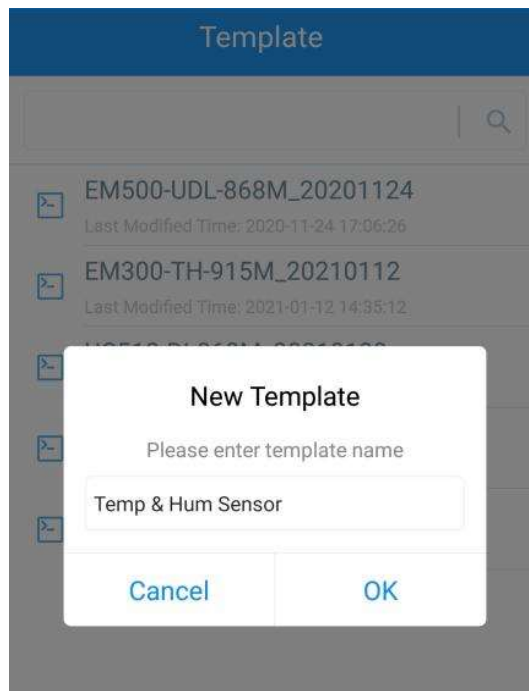

**Note:** Slide the template item to the left to edit or delete the template. Click the template to edit the configurations.

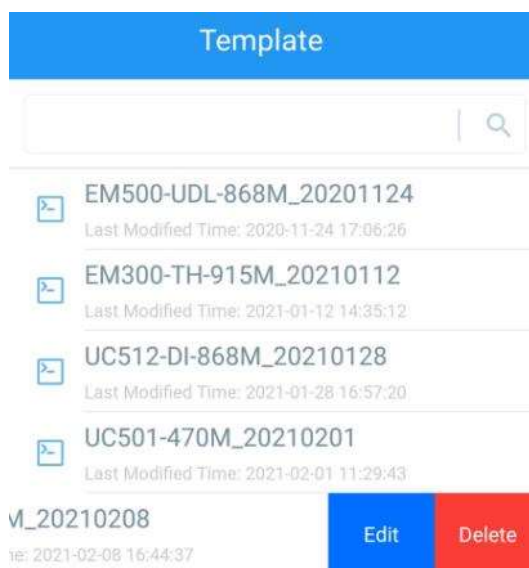

### 3.5.3 Reset to Factory Default

Please select one of the following methods to reset device:

**Via Hardware:** Press and hold the power button for more than 10s until the indicator blinks quickly, then the device starts resetting.

**Via ToolBox App:** Go to **Device > Maintenance** to tap **Reset**, then attach a smartphone to the device via NFC to complete the reset.

Status	Setting	Maintenance
SN	6787D18008970013	
Model	VS341-470M	
Firmware Version	V1.1-a2	
Hardware Version	V1.0	
Manual Upgrade		
<a href="#">Browse</a>		
Restore Factory Default		
<a href="#">Reset</a>		



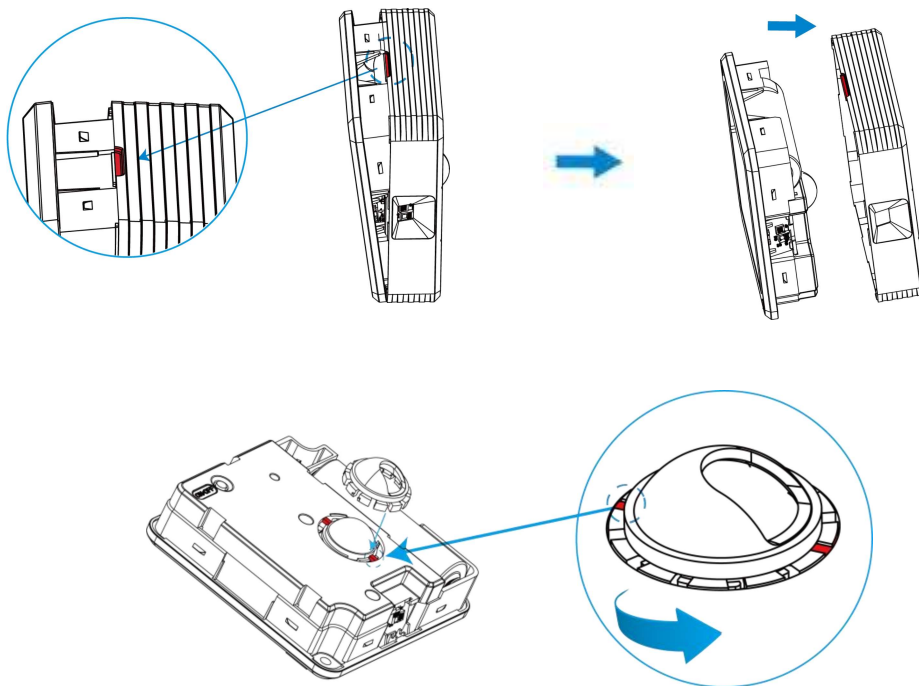

## 4. Installation

### PIR Cover Installation:

Take off the front cover of the device, then select the PIR cover as required and put it on the PIR sensor with groove alignment. The adjustable angle of every groove is 30°.

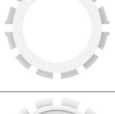

PIR cover reference guidance (installation height=70cm):

PIR Cover	Detection Area	Usage Scenario
	70 ° Horizontal, 60 ° Vertical, 1 m × 0.9 m	Single Person Desk
	70 ° Horizontal, 107 ° Vertical, 1 m × 1.8 m	Face to Face Desk
	107 ° Horizontal, 53.5 ° Vertical, 1.8 m × 0.9 m	Bar Table
	107 ° Horizontal, 107 ° Vertical, 1.8 m × 1.8 m	Round Table
	N/A	Support to be tailored as required

### Fixed by 3M Tape:

Attach 3M tape to the back of sensor, then tear the other side and place it under the working desk. Please adjust the installation direction according to the detection area and ensure that the thermopile sensor should be placed toward the seat.

#### Note:

1. Since the default 3M tape has a high viscosity, please tear the device down via screwdriver.
2. If it is necessary to tear the device down easily, please divide the 3M tape as several parts and only tear one part to device.

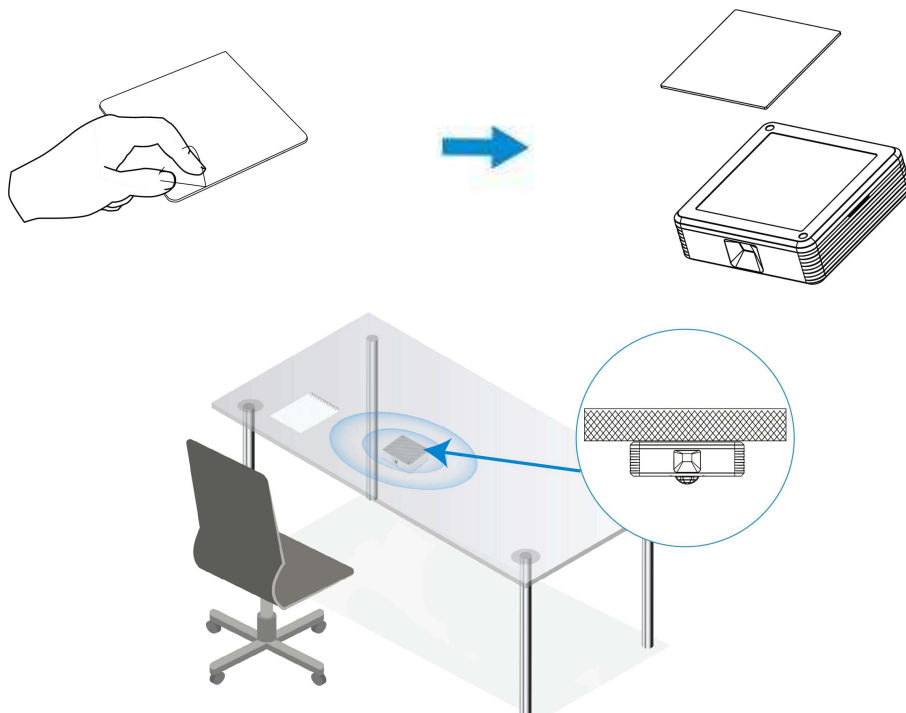

## Fixed by Mounting Kits:

1. Take off the front cover of the device, then fix the wall plugs under the desk according to the device mounting holes, and fix the device to the wall plugs with screws. Please adjust the installation direction according to the detection area and ensure that the thermopile sensor should be pointed to the seat.
2. Restore the front cover back to the device.

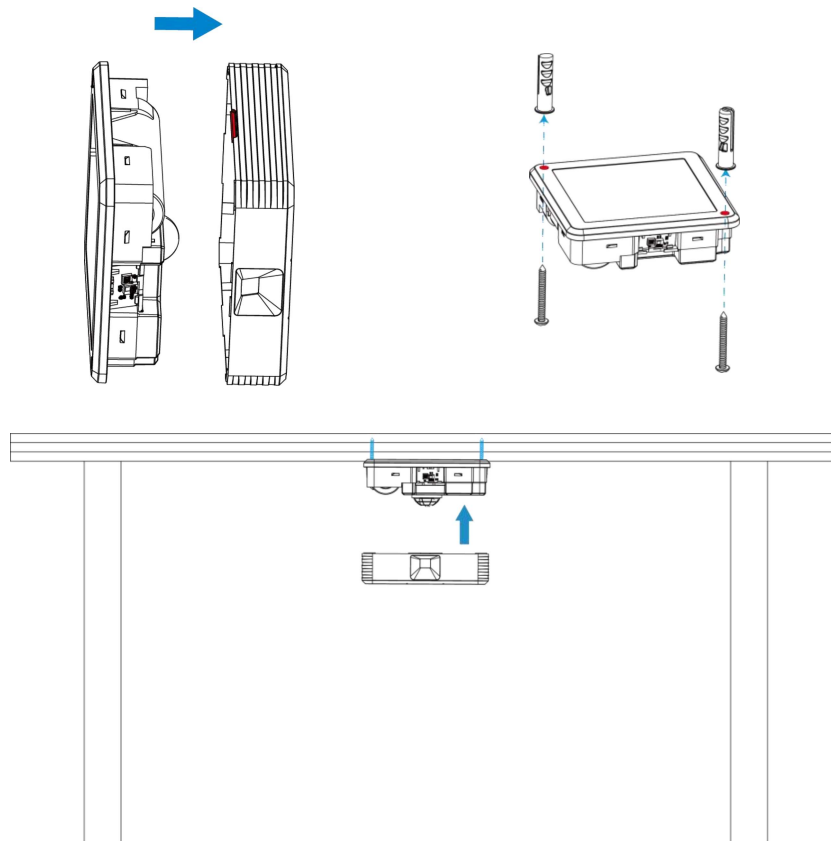

### Installation Note:

1. Ensure the detection area is not blocked by curtains or barriers.
2. The recommended installation distance of VS340 is 0 to 50 cm away from the table edge.
3. The recommended installation distance of VS341 is 0 to 40 cm away from the table edge. Besides, the best distance is 20 to 40 cm.

## 5. Device Payload

All the data is based on the following format (HEX), the Data field should follow the little-endian:

Channel1	Type1	Data1	Channel2	Type2	Data2	Channel 3	...
1 Byte	1 Byte	N Bytes	1 Byte	1 Byte	M Bytes	1 Byte	...

For decoder examples please find the files on

<https://github.com/Milesight-IoT/SensorDecoders>.



## 5.1 Basic Information

VS34x sensor reports basic information about itself whenever joining the network.

Channel	Type	Description
ff	01 (Protocol Version)	01=>V1
	09 (Hardware Version)	01 40 => V1.4
	0a (Software Version)	01 14 => V1.14
	0b (Power On)	Device is on
	16 (Device SN)	16 digits
	0f (Device Type)	00: Class A, 01: Class B, 02: Class C

Example:

ff0bff ff0101 ff166787d18008970013 ff090100 ff0a0101 ff0f00					
Channel	Type	Value	Channel	Type	Value
ff	0b (Power On)	ff (Reserved)	ff	01 (Hardware Version)	01 (V1)
Channel	Type	Value	Channel	Type	Value
ff	16 (Device SN)	6787d18008970 013	ff	09 (Hardware Version)	0110 (V1.1)
Channel	Type	Value	Channel	Type	Value
ff	0a (Software Version)	0101 (V1.1)	ff	0f (Device Type)	00 (Class A)

## 5.2 Sensor Data

VS34x sensor reports data according to the reporting interval (1440 mins by default) or when occupancy status changes.

Item	Channel	Type	Description
Battery Level	01	75	UINT8, Unit: %
Occupancy Status	03	00	00: Vacant; 01: Occupied

Example:

017564 030001					
Channel	Type	Value	Channel	Type	Value
01	75 (Battery Level)	64=>100%	03	00 (Occupancy Status)	01=Occupied

## 5.3 Downlink Commands

VS34x sensor supports downlink commands to configure the device. The application port is 85 by default.

Channel	Type	Description
ff	10 (Reboot)	1 Byte, ff
	2f (LED Indicator)	1 Byte, 00: disable; 01: enable
	8e (Reporting Interval)	3 Bytes, Byte 1: 00 Byte 2-3: interval time, unit: min
	95 (Time to report vacancy)	2 Bytes, unit: s
	84 (D2D Feature)	1 Byte, 00: disable; 01: enable
	35 (D2D Key)	8 Bytes
	96 (D2D Settings)	8 Byte, Byte 1: 00-occupied, 01-vacant Byte 2: 00-disable, 01-enable Byte 3: 00-disable LoRa Uplink, 01-enable LoRa Uplink Byte 4-5: D2D control command Byte 6-7: control time, unit: min Byte 8: 00-disable control time, 01-enable control time

**Examples:**

1. Set reporting interval as 2 minutes.

ff8e 00 0200		
Channel	Type	Value
ff	8e (Reporting Interval)	02 00=>00 02=2 minutes

2. Reboot the device.

ff10ff		
Channel	Type	Value
ff	10 (Reboot)	ff (Reserved)

3. Set time to report vacancy.

ff957800		
Channel	Type	Value
ff	95 (Time to report vacancy)	78 00=>00 78=>120s

4. Enable D2D feature.

ff8401		
--------	--	--

Channel	Type	Value
ff	84 (D2D Feature)	01=Enable

## 5. Set D2D Key.

ff355572404C696E6B4C		
Channel	Type	Value
ff	35 (Set D2D Key)	5572404C696E6B4C

## 6. Set D2D settings.

ff96 00 01 01 04e0 0500 01		
Channel	Type	Value
ff	96 (Set D2D Settings)	00=>Occupied; 01=>Enable; 01=>Enable LoRa Uplink; 04 e0=> e0 04, Control Command is e0 04; 05 00 => 00 05, Control time is 5 mins; 01=>Enable Control Time

-END-