

SDM230-LoRaWAN

DIN Rail Smart Energy Meter for Long Range Wireless Communication



USER MANUAL

2020 V1.0

Contents

1. Introduction	1
1.1 Unit Characteristics	1
1.2 Pulse Outputs	1
1.3 LoRaWAN Classes	1
1.4 Active Upload Mode	1
1.5 Join	2
1.6 Communication	2
2. Start Up Screens	4
3. Measurements	5
4 Setting Up	10
4.1 Setting 1	11
4.1.1 Pulse Output Type	11
4.1.2 Pulse Constant	11
4.1.3 Pulse Duration	12
4.1.4 Demand Interval Time (DIT)	13
4.1.5 Automatic Scroll Time Interval	13
4.1.6 Backlight Time(LP)	14
4.1.7 Clear Demand Information	15
4.1.8 Password	16
4.1.9 Checking Meter Information	17
4.3 Setting 2	20
4.3.1 Join Information	20
4.3.2 Join Mode: OTAA/ABP	22
4.3.3 Re-Join	22
4.3.4 Auto: Upload ON/OFF, Upload Interval Time	23
4.3.5 Join Delay	24
4.3.6 OFF Line	25
4.3.7 Confirm Mode	26
5 Specifications	27
6 Maintenance	28
7 Installation	29
7.1 Safety	29
7.2 EMC Installation Requirements	29
7.3 Dimensions	30
7.4 Wiring Diagram	30

1 Introduction

This document provides operating, maintenance and installation instructions .

The unit measures and displays the characteristics of single phase two wire(1p2w) supplies, including kWh, kVAh, kW, kVA, PF, Frequency, Voltage, Current, dmd. THD etc. It support Max.100A direct connection, saving the cost to install external CTs. Maximum demand current can be measured over preset periods of up to 60 minutes.

This unit has a built-in LoRaWAN module which allows long range wireless communication. Two pulse outputs are available for real time energy measurement.

1.1 Unit Characteristics

The Unit can measure and display:

- voltage and current
- Frequency
- Power, maximum power demand and power factor
- Active energy imported and exported
- Reactive energy imported and exported

The unit has password-protected set-up screens for:

- Changing password
- Demand Interval time, backlight time,scroll display time
- Reset for demand and partial energy measurements
- Pulse output type/ constant/ duration

1.2 Pulse outputs

The unit provides two pulse outputs. Both pulse outputs are passive type.

Pulse output 1 is configurable. The pulse output can be set to generate pulses to represent total/ import/ export kWh or kVAh.

The pulse constant can be set to generate 1 pulse per:

1 = 1 kWh/kVAh

10 = 10 kWh/kVAh

100 = 100 kWh/kVAh

1000=1000 kWh/kVAh

Pulse width: 200/100(default)/60ms.

Pulse output 2 is non-configurable. It is fixed to export kWh. The constant is 1000imp/kWh.

1.3. LoRaWAN Classes

Eastron LoRaWAN energy meter is implement Class C functionality. The device will upload message after receiving the data sent from the network.

1.4 Active Upload Mode

The device also can be customized to active upload mode. Total 19 parameters can be set for automatic uploading.

Interval time can be set from 0 to 255 through communication. 0 means the function is OFF. If

there are many parameters, the interval shouldn't be set too short in case of conflicting on data uploading.

The meter will upload automatically once it joins the network. And after the interval time, it will upload again.

The interval time is calculated since the last data uploading. Sometimes the interval time may have around 1-2 minutes difference due to the timer error.

1.5 Join

The unit uses standard LoRaWAN protocol for long range communication. Before Communication, the meter has to join the LoRaWAN network first.

There are two Activation Ways for Joining: OTAA(Over-the-Air Activation) and ABP(Activation by Personalization).

To ensure the meter join gateway successfully, below information must be confirmed:

- I. DevEui, AppEui, Appkey or DevAddr, NwksKey, AppSKey information are correctly recorded into the gateway.
- II. The Uplink and downlink frequency are same as the gateway.
- III. RX2 (frequency and SF) information are same as the gateway.

If the Join delay function is ON, the meter will join the network with a few seconds delay by random.

1.6 Communication

LoRaWAN meter communicate based on international general purpose protocol. The communication data is placed in data segment of LoRaWAN protocol, they will be appointed follow the specified command format.

The format of standard LoRaWAN is shown below:

Radio PHY layer:						
Preamble	PHDR	PHDR_CRC	PHYPayload			CRC*
			MHDR	MACPayload		MIC
			MHDR	FHDR	Fport	FRMPayload
						MIC
Note: CRC* is only available on uplink messages						

The following description of the text is defined the data in the segment of **FRMPayload** region in LoRaWAN protocol. The software in PC only need to get this part of data from gateway. According to the following protocol definition to parse the data.

The data format and encoding of meter communication protocol are modified based on the Modbus ASCII transmission mode. Remove the start and end characters from the Modbus ASCII transmission mode and change LRC validation to CRC validation.

Encoding of data: communication data is encoded with ASCII, and each byte of data is sent with two ASCII characters.

E.g.: a byte data 0x5b is encoded as two characters: 0x35 and 0x62 (ASCII code 0x35= "5", 0x62= "b")

Command format definition:

I: The data format of the gateway sending the copy command:

Reserved	Function Code	The first Address of The Register to Read Data	The Number of Registers to Read Data	CRC Check Codes
1byte	1byte	2byte	2byte	2byte

Note: the reserved bit is fixed as 0x01

II: the data format returned by the meter after receiving the copy command:

Reserved	Function Code	The Length of Data Returned	Specific Data Returned by The Meter	CRC Check Codes
1byte	1byte	1byte	N byte	2byte

Note: the reserved bit is fixed as 0x01

III: Note: the above commands need to be ASCII, so 1byte data will have 2 characters.

E.g.

1). Suppose to read the current data of the meter L1, the data sent by the gateway is the ASCII coded data as shown in the following table:

Reserved	Function Code				The first Address of The Register to Read Data				The Number of Registers to Read Data				CRC Check Codes				
0x01	0x04				0x00 0x06				0x00 0x02				0x91 0xca				Hexadecimal Data
0x30	0x31	0x30	0x34	0x30	0x30	0x30	0x36	0x30	0x30	0x30	0x32	0x39	0x31	0x63	0x61	ASCII Coded Data	
"0"	"1"	"0"	"4"	"0"	"0"	"0"	"6"	"0"	"0"	"0"	"2"	"9"	"1"	"c"	"a"	ASCII Character	

Note: the first address of the register of the meter L1 current is 00 06 and the number of registers is 2.

2) After receiving the above command, the meter will return the current L1 current data of the meter, as shown in the following table after ASCII coding.



Reserved	Function Code	The Length of Data Returned	current L1 current data of the meter										CRC Check Codes						
0x01	0x04	0x04	0x40	0xa0	0x00	0x00	0x00	0x00	0x00	0x00	0x00	0x00	0x00	0x00	0xee	0x66	Hexadecima l Data		
0x30	0x31	0x30	0x34	0x30	0x30	0x34	0x30	0x61	0x30	0x30	0x30	0x30	0x30	0x30	0x65	0x65	0x36	0x36	ASCII Coded Data
"0"	"1"	"0"	"4"	"0"	"0"	"4"	"0"	"a"	"0"	"0"	"0"	"0"	"0"	"e"	"e"	"6"	"6"	ASCII Character	

Note: Assume that the current meter's L1 current is 5.0A, since the data is in floating point format, the Hex data is converted to 0x40, 0xa0, 0x00 and 0x00.

To ensure the successful communication, below information must be confirmed:

1. The command is sent through Class C mode.
2. The command is sent in ASCII format.

2. Start Up Screens



	<p>The first screen lights up all display segments and can be used as a display check.</p>
	<p>The second screen indicates the firmware version. (left picture is for reference only)</p>

	<p>The interface performs a self-test and indicates the result if the test passes.</p>
---	--



*After a short delay, the screen will display active energy measurements.





3. Measurements





The buttons operate as follows:





	<p>Selects the measured parameters In Set-up Mode, this is the “Up” button.</p>
	<p>In Set-up Mode, this is the “Enter”, “Left” and “Confirm” button</p>

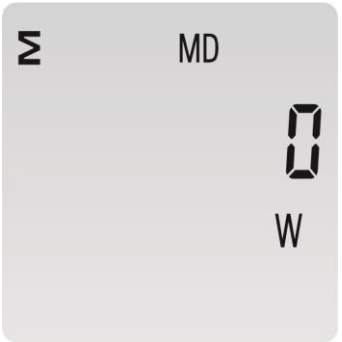



The display order by scroll button  :



	<p>Total kWh</p>
	<p>Import kWh</p>

 <p>EXP 000000.00 kWh</p>	Export kWh
 <p>Σ 000000.00 kWh</p>	Resettable total kWh
 <p>Σ 000008.03 kVArh</p>	Total kVArh
 <p>IMP 000000.00 kVArh</p>	Import kVArh

 <p>EXP 000000.00 kVArh</p>	Export kVArh
 <p>Σ 000000.00 kVArh</p>	Resettable total kVArh
 <p>Σ MD 0 W</p>	Max. power demand
 <p>218.4 V</p>	Voltage



 <p>000000.00 A</p>	Current
 <p>0 W</p>	Active Power
 <p>0 VAr</p>	Reactive Power
 <p>0 VA</p>	Apparent Power

	Power Factor
	Frequency
	Pulse constant
	ID (High address)

	ID (Low address)
	Total running time

4. Setting Up







To enter set-up mode, pressing the  button for 3 seconds, until the password screen appears.

Display	Descriptions
	The setting is done correctly
	The setting is not correct

4.2 Setting 1

Input Password "1000", press  for 3s to enter into the setting up page.





4.2.1 Pulse Output Type:

	<p>Pulse Output Type Default: kVArh Range: kVArh, imp kVArh, Exp kVArh, kWh, Exp kWh, imp kWh.</p>
	<p>Press  for 3s, the red part will flash. Press  to choose the required selection.</p>
	<p>Press  for 3s to confirm.</p>





4.2.2 Pulse Constant



Use this to set the energy represented by each pulse

	<p>Pulse Constant Default: 1000 kWh (means 1 impulse represent 1000kWh) Range: 1 / 10/ 100/ 1000 kWh</p>
---	---







	<p>Press  for 3s, the red part will flash.</p> <p>Press  to choose the required selection.</p>
	<p>Press  for 3s to confirm the setting.</p>

4.2.3 Pulse Duration







	<p>Pulse Duration Default: 200 Range: 60/ 100/ 200 mS</p>
	<p>Press  for 3s, the red part will flash. Press  to choose the required selection.</p>

	<p>Press  for 3s to confirm the setting.</p>
---	---

4.2.4 Demand Interval Time (DIT)





	<p>The screen will show the currently selected integration time. Default: 60 Range: 60/ 30/ 15/ 10/ 5/ OFF</p>
	<p>Press  for 3s, the current demand interval time will flash. Press  to choose the required selection.</p>
	<p>Press  for 3s to confirm the setting.</p>

4.2.5 Automatic Scroll Time Interval

	<p>Automatic Scroll Time Interval Default: 0 S Option: 0 ~ 30S</p>
	<p>Press  for 3s, the current system type will flash. Press  to choose the required setting.</p>
	<p>Press  for 3s to confirm.</p>





4.2.6 Backlight Time (LP)





	<p>The screen will show the currently selected backlight time. Default: 60 minutes Range: 120/ 60/ 30/ 20 / 10/ 5 / OFF If it is seated as 5, the backlit will be off in 5 minutes.</p>
---	--

	<p>Press  for 3s, the current backlight time will flash. Press  to choose the required selection.</p>
	<p>Press  for 3s to confirm.</p>



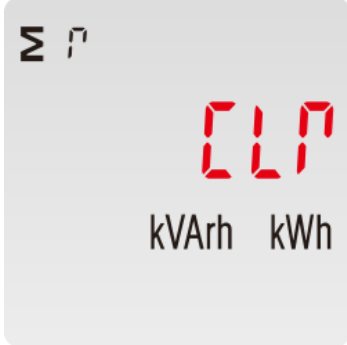

4.2.7 Clear Demand Information



This option is to reset the demand and resettable kWh/kVAh information.

	<p>From the Set-up menu, use  buttons to select the clear option.</p>
	<p>Press  for 3s. The CLR will flash.</p> <p>Press  again for 3s to confirm the resetting.</p>

	<p>Press  button enter into the kWh/kVArh reset page.</p>
	<p>Press  for 3s. The CLR will flash.</p> <p>Press  again for 3s to confirm the resetting.</p>

4.2.8 Password



	<p>The screen shows the current password. Default: 1000 Range: 0001-9999</p>
	<p>Press  for 3s, the current digit will flash.</p> <p>Press  to choose the required digit,</p> <p>press  to move to the next digit.</p>



	Press  for 3s to confirm.
---	--

4.2.14 Checking Meter Information

This function allows to check meter setting information, also some of below information can be set through another password (refer to section 4.3).

1) Join Information

1		Activation Way: OTAA DevEui: end-device identifier ***** (16 digits)
1-1		Activation Way: ABP DevAddr: End-device address ***** (8 digits)
2		Activation Way: OTAA AppEui: application identifier ***** (16 digits)



2-1		<p>Activation Way: ABP</p> <p>NwkSKey: Network session key</p> <p>***** (32 digits)</p>
3		<p>Activation Way: OTAA</p> <p>AppKey: Application key</p> <p>***** (32 digits)</p>
3-1		<p>Activation Way: ABP</p> <p>AppSKey: Application session key</p> <p>***** (32 digits)</p>

2) Join Status

1		<p>JOIN OK</p> <p>Means the meter is connected to the gateway successfully</p>
---	---	--

1-1		<p>JOIN FAIL</p> <p>Means the meter is failed to connect to the gateway</p> <p>Meanwhile, the display will show EER1</p>
-----	---	--



3) Join Mode

1		JOIN MODE: OTAA
1-2		JOIN MODE: Abp

4) AUTO

When AUTO function is ON, the meter will send a command to gateway automatically to check the connection status with gateway. Interval time is configurable.

1		AUTO
---	---	------

1-2		UP LOAd: OFF Means AUTO function is CLOSED, otherwise it will show ON
1-3		Interval Time Option: 5/ 10/ 20/ 30/ 90/ 120/ 150/ 180/ 210/ 240 minutes

5) Meter ID

1		Meter ID/ Serial Number ***** (8 digits)
---	---	--

4.3 Setting 2

Input Password "2308", press  and  together for 3s to enter the setting up page.















The first page will show join status between the meter and gateway. Use  to choose the options required.



Below information can be adjusted through password "2308":

4.3.1 Join Information:







Join information including DevEui, AppEui, Appkey under OTAA mode and DevAddr, NwkSKey, AppSKey under ABP mode.

Take OTAA setting as an example:





	<p>DevEui: 9132000001324013</p> <p>The 16 digits will be shown on 4 pages. Each page shows 4 digits.</p> <p>Press  for 3s, enter into the P1 setting page.</p>
	<p>Press  for 3s, the first digit will flash. Use  and  to choose the option.</p> <p>Press  for 3s again to confirm the setting.</p>
	<p>Press  to move to the P2 setting page.</p> <p>Use  and  to do the same operation as P1.</p> <p>And then set the same on P3 and P4</p>
	<p>After P4 setting, Press  return to the DevEui page, press  move to the next setting page: AppEui and Appkey.</p> <p>Use the same way to set AppEui and Appkey.</p>

	<p>After above setting, press  to move to the SAVE page. Long Press  button to save above setting.</p>
---	--

4.3.2 Join Mode: OTAA/ ABP

	<p>Join mode Option: OTAA, ABP</p>
	<p>Press  for 3s, the current option will flash. Use  to choose the option.</p>
	<p>Press  for 3s to confirm.</p>







4.3.3 Re-Join









	<p>Re-Join This function allows the meter re-join the network when disconnected.</p>
	<p>Press  for 3s, the current option will flash. Long press  again, the meter will re-join the network automatically.</p>

4.3.4 Auto: Upload ON/OFF, Upload Interval Time

When Auto is ON, the meter will send a command to gateway automatically. This is for the gateway to check if the meter is still online.

Under Active upload mode, the Auto function is not used.









	<p>From the Set-up menu, use  buttons to select the AUTO option. Press  for 3s enter to the setting page.</p>
	<p>UP LOAd: OFF Range: ON/OFF Press  for 3s, the current option will flash. Use  to choose the option.</p>

	<p>Press  for 3s to confirm.</p>
	<p>Interval Time Option: 30 / 60 / 90 / 120 / 150 / 180 / 210 / 240 minutes</p> <p>30 means the meter will send a command to gateway every 30 minutes.</p>
	<p>Press  for 3s, the current option will flash.</p> <p>Use  to choose the option.</p>
	<p>Press  for 3s to confirm.</p>

4.3.5 Join Delay

When Join delay function is ON, the meter will join the LoRaWAN network with a few seconds delay after booting.



When Join delay function is OFF, the meter will join the LoRaWAN network once the power is on.

	<p>From the Set-up menu, use  buttons to select the JOIN DLY option.</p> <p>Press  for 3s enter to the setting page.</p>
	<p>DLY: OFF Range: ON/OFF</p> <p>Press  for 3s, the current option will flash.</p> <p>Use  to choose the option.</p>
	<p>Press  for 3s to confirm.</p>

4.3.6 OFF Line

This function is used to check the connection status between meter and the network/gateway. To check the connections, the network will send data to the end-device at intervals. If over a period, the meter doesn't receive data from gateway, the meter will be considered OFF line and it will re-join the network.

	<p>OFF Line Option: 0/ 30/ 60/ 90/ 120/ 150/ 180/ 210/ 240 minutes Default: 60 minutes 60 minutes means from the last message received from gateway, if over 60 minutes not receiving message, the meter will be considered OFFLINE and will re-join the network automatically.</p>
---	---



	<p>Press  for 3s, the current option will flash.</p> <p>Use  to choose the option.</p>
	<p>Press  for 3s to confirm.</p>

NOTE: Under the active upload mode, the OFF Line time should be set to a value bigger than the active upload interval time.

4.3.7 Confirm Mode

When the Confirm mode is ON, the meter will request the LoRaWAN network to confirm the reception of its message.

If there is no message received, it means the network has not received the uplink. The Meter will send uplink again, upon to 3 times.

	<p>From the Set-up menu, use  buttons to select the Confirm mode option.</p>
	<p>Press  for 3s, the current option will flash.</p> <p>Use  to choose the option.</p>

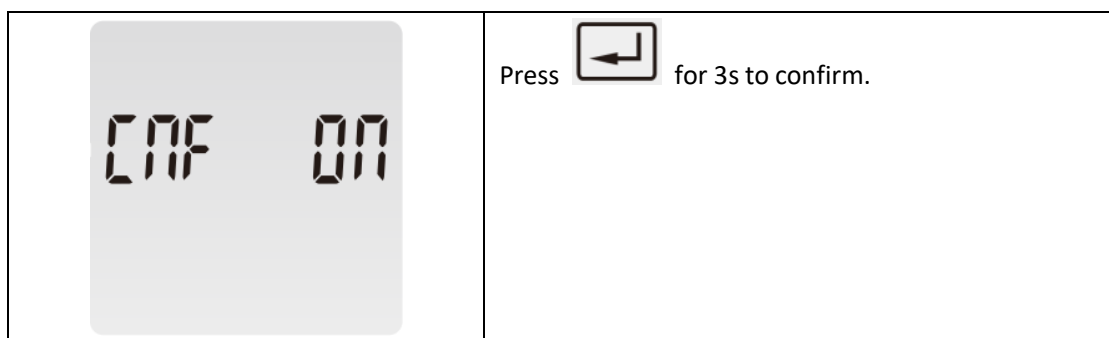

5 Specifications

Electrical characteristics		
Type of measurement	RMS including harmonics on single phase AC system	
Measurement accuracy	Active Energy	IEC 62053-21 Class 1
	Reactive Energy	± 0.01
	Frequency	± 0.2%
	Current	± 0.5%
	Voltage	± 0.5%
	Power	± 0.01
	Power Factor	± 0.01
Data Update Rate	1 second nominal	
Input Voltage	Un	230 V L-N
	Measured Voltage with Over-range	176 to 276 Vac L-L
	Impedance	1M Ω
Input Current	Measured current with Over-range	0.5-10(100)A
	Withstand	30 I _{max} . for 0.1 Seconds
	Impedance	< 1M Ω
Frequency Range	45~65Hz	
Max. reading	99999.99 kWh/ kVArh	
Mechanical Characteristics		
Weight	250g	
IP Degree of Protection (IEC 60529)	IP51 (indoor)	
Dimensions (WxHxD)	100x36x63mm	
Mounting	Din rail (DIN 43880)	
Material of meter case	Self-extinguishing UL 94 V-0	
Mechanical environment	M1	

Environmental Characteristics	
Operating Temperature	-25 to 55°C
Storage Temperature	-40 to 70°C
Humidity Rating	<95% RH at 50 °C (non-condensing)
Pollution Degree	2
Altitude	2000m
Vibration	10Hz to 50Hz, IEC 60068-2-6
Safety	
Measurement Category	Per IEC61010-1 CAT III
Current Inputs	Require external Current Transformer for Insulation
Over voltage Category	CAT II
Dielectric Withstand	As per IEC 61010-1 Double Insulated front panel display
Protective Class	II
Communications	
Interface standard and protocol	LoRaWAN
Frequency	EU868/AS923/AU915/ US902
LoRaWAN Classes	Class C
Coding Format	ASCII
Communication Distance	2000M in an open area

6 Maintenance

In normal use, little maintenance is needed. As appropriate for service conditions, isolate electrical power, inspect the unit and remove any dust or other foreign material present. Periodically check all connections for freedom from corrosion and screw tightness, particularly if vibration is present.

The front of the case should be wiped with a dry cloth only. Use minimal pressure, especially over the viewing window area. If necessary, wipe the rear case with a dry cloth. If a cleaning agent is necessary, isopropyl alcohol is the only recommended agent and should be used sparingly. Water should not be used. If the rear case exterior or terminals should be contaminated accidentally with water, the unit must be thoroughly dried before further use. Should it be suspected that water might have entered the unit, factory inspection and refurbishment is recommended.

In the unlikely event of a repair being necessary, it is recommended that the unit be returned to the factory or nearest Eastron distributor.

7 Installation

7.1 Safety

The unit is designed in accordance with IEC 61010-1:2017 – Permanently connected use, Normal condition. Installation category III, pollution degree 2, basic insulation for rated voltage.

7.2 EMC Installation Requirements

Whilst this unit complies with all relevant EU EMC (electro-magnetic compatibility) regulations, any additional precautions necessary to provide proper operation of this and adjacent equipment will be installation dependent and so the following can only be general guidance:

Avoid routing wiring to this unit alongside cables and products that are, or could be, a source of interference.

The auxiliary supply to the unit should not be subject to excessive interference. In some cases, a supply line filter may be required.

To protect the product against incorrect operation or permanent damage, surge transients must be controlled. It is good EMC practice to suppress transients and surges at the source. The unit has been designed to automatically recover from typical transients; however, in extreme circumstances it may be necessary to temporarily disconnect the auxiliary supply for a period of greater than 10 seconds to restore correct operation.

Screened communication leads are recommended and may be required. These and other connecting leads may require the fitting of RF suppression components, such as ferrite absorbers, line filters etc., if RF fields cause problems.

It is good practice to install sensitive electronic instruments that are performing critical functions in EMC enclosures that protect against electrical interference causing a disturbance in function.



- **During normal operation, voltages hazardous to life may be present at some of the terminals of this unit. Installation and servicing should be performed only by qualified, properly trained personnel abiding by local regulations. Ensure all supplies are de-energized before attempting connection or other procedures.**
- **Terminals should not be user accessible after installation and external installation provisions must be sufficient to prevent hazards under fault conditions.**
- **This unit is not intended to function as part of a system providing the sole means of fault protection - good engineering practice dictates that any critical function be protected by at least two independent and diverse means.**

- The unit does not have internal fuses therefore external fuses must be used for protection and safety under fault conditions.
- Never open-circuit the secondary winding of an energized current transformer.
- This product should only be operated with CT secondary connections Earthed.
- If this equipment is used in a manner not specified by the manufacturer, protection provided by the equipment may be impaired.

7.3 Dimensions

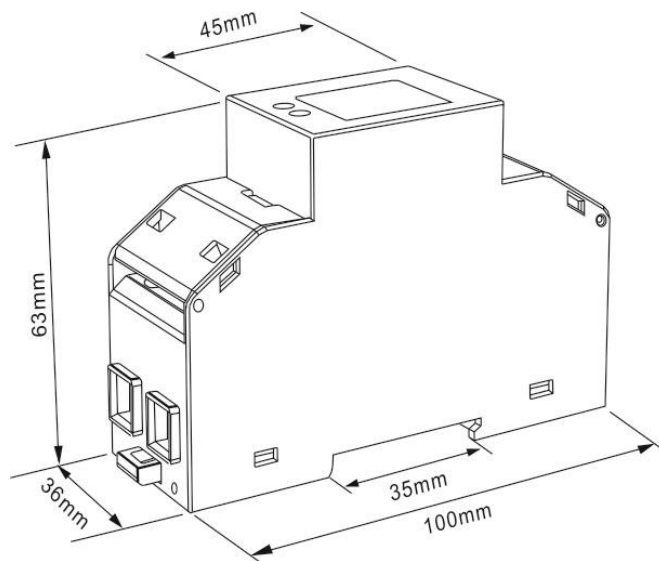

7.4 Wiring Diagram

